

Lincoln Electric Europe

# LINC TORCH™

**LINCOLN**  
**ELECTRIC**



# Products

## LINC TORCH™

With the LINC TORCH range, Lincoln Electric offers a complete collection of TIG welding torches.

No matter what the application, there will be a perfectly suitable torch for the job. The highly flexible European range of welding torches contains Water and Air-cooled torches equipped with different heads. The differentiation of welding heads will allow easy selection of the right torch; small and light weight for small plate thickness or areas that are difficult to reach, or the standard torch head's designed for 90% of the applications. Our different ceramic nozzles will support welding in narrow grooves or at high Amperages and gas-flows.

All our torches can be equipped with gas-lenses. The gas-lens will provide a laminar gas-flow that results in better protection of the weld pool. The use of a gas-lens also allows a reduction of gas flow, giving an overall saving.

Linc Torches are designed with the welder in mind, the ergonomic grip and the flexible "ball joint" on the end of the torch body together with the flexible cable will support a torch which is easy to manipulate and a pleasure to work with.

## LINC TORCH™ Product Range

- **LT9G** Air-cooled Ergonomic grip  
Air-cooled Lever grip
- **LT17G** Air-cooled Ergonomic grip  
Air-cooled Lever grip
- **LT17V** Air-cooled with manual valve
- **LT18W** Water-cooled Ergonomic grip  
Water-cooled Lever grip
- **LT20W** Water-cooled Ergonomic grip  
Water-cooled Lever grip
- **LT26G** Air-cooled Ergonomic grip  
Air-cooled Lever grip

*All torches are available with 4 and 8-meter length cable packages.*

## Advantage

- ✓ Complete range to support all your welding applications
- ✓ High quality manufactured to Lincoln standards
- ✓ Ergonomic grip for comfortable welding day in and day out
- ✓ Flexible ball joint to manipulate the torch easily
- ✓ Rugged and flexible cable packages
- ✓ Industry standard front end torch consumables
- ✓ Truly rated meeting CE IEC60974-1 and EN50078



Ergonomic grip

Ball joint



Lever grip

# Torches Air-cooled

## LT 9 G Air-cooled

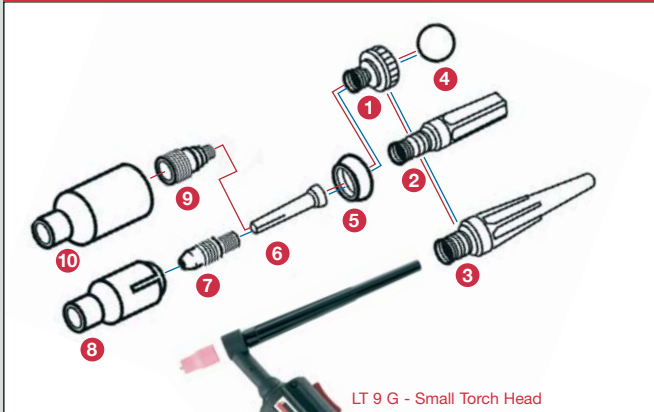

LT 9 G - Small Torch Head

Product	Item nr.	Amp.
LT 9 G 4 mtr Ergo	K10513-9-4	110 A DC 80 A AC @ 35%
LT 9 G 8 mtr Ergo	K10513-9-8	
LT 9 G 4 mtr Lever	K10513-9-4F	
LT 9 G 8 mtr Lever	K10513-9-8F	
Accessory kit 1,0 - 1,6 mm	KP10516-9	

## LT 17 G Air-cooled



LT 17 G - Standard Torch Head

Product	Item nr.	Amp.
LT 17 G 4 mtr Ergo	K10513-17-4	140 A DC 100 A AC @ 35%
LT 17 G 8 mtr Ergo	K10513-17-8	
LT 17 G 4 mtr Lever	K10513-17-4F	
LT 17 G 8 mtr Lever	K10513-17-8F	
Accessory kit 1,6 - 2,4 mm	KP10516-11	

Item	Description	Int.	Pcs./pck
------	-------------	------	----------

Item	Description	Int.	Pcs./pck
1	KP10508-1 Short cap	41V33	10
2	KP10508-2 Medium cap	41V35	10
3	KP10508-3 Long cap	41V24	10
4	KP10508-4 O-ring	VS-1-02	10
5	KP10510-1 Standard Insulator	598882	10
6	1,0 mm KP10502-10 Collet	13N21	10
6	1,6 mm KP10502-16 Collet	13N22	10
6	2,4 mm KP10502-24 Collet	13N23	10
6	3,2 mm KP10502-32 Collet	13N24	10
7	0,5-1,0 mm KP10504-10 Collet Body	13N26	10
7	1,6 mm KP10504-16 Collet Body	13N27	10
7	2,4 mm KP10504-24 Collet Body	13N28	10
7	3,2 mm KP10504-32 Collet Body	13N29	10
8	6,5 mm KP10512-4 Ceramic Nozzle	13N08	10
8	8,0 mm KP10512-5 Ceramic Nozzle	13N09	10
8	9,5 mm KP10512-6 Ceramic Nozzle	13N10	10
8	11,0 mm KP10512-7 Ceramic Nozzle	13N11	10
8	12,5 mm KP10512-8 Ceramic Nozzle	13N12	10
8	16,0 mm KP10512-10 Ceramic Nozzle	13N13	10
9	0,5-1,0 mm KP10506-10 Gas-lens	45V42	10
9	1,6 mm KP10506-16 Gas-lens	45V43	10
9	2,4 mm KP10506-24 Gas-lens	45V44	10
9	3,2 mm KP10506-32 Gas-lens	45V45	10
10	6,5 mm KP10513-4 Ceramic Nozzle	53N58	10
10	8,0 mm KP10513-5 Ceramic Nozzle	53N59	10
10	9,5 mm KP10513-6 Ceramic Nozzle	53N60	10
10	11,0 mm KP10513-7 Ceramic Nozzle	53N61	10
10	12,5 mm KP10513-8 Ceramic Nozzle	53N61S	10

Item	Description	Int.	Pcs./pck
------	-------------	------	----------

Item	Description	Int.	Pcs./pck
1	KP10509-1 Short cap	57Y04	10
2	KP10509-2 Medium cap	57Y05	10
3	KP10509-3 Long cap	57Y02	10
4	KP10509-4 O-ring	300M02	10
5	KP10511-1 Standard Insulator	18CG	10
6	1,0 mm KP10503-10 Collet	10N22	10
6	1,6 mm KP10503-16 Collet	10N23	10
6	2,4 mm KP10503-24 Collet	10N24	10
6	3,2 mm KP10503-32 Collet	10N25	10
6	4,0 mm KP10503-40 Collet	54N20	10
7	0,5-1,0 mm KP10505-10 Collet Body	10N30	10
7	1,6 mm KP10505-16 Collet Body	10N31	10
7	2,4 mm KP10505-24 Collet Body	10N32	10
7	3,2 mm KP10505-32 Collet Body	10N28	10
8	6,5 mm KP10514-4 Ceramic Nozzle	10N50	10
8	8,0 mm KP10514-5 Ceramic Nozzle	10N49	10
8	9,5 mm KP10514-6 Ceramic Nozzle	10N48	10
8	11,0 mm KP10514-7 Ceramic Nozzle	10N47	10
8	12,5 mm KP10514-8 Ceramic Nozzle	10N46	10
8	16,0 mm KP10514-10 Ceramic Nozzle	10N45	10
8	19,0 mm KP10514-12 Ceramic Nozzle	10N44	10
9	KP10511-1 Standard Insulator	18CG	10
10	0,5-1,0 mm KP10507-10 Gas-lens	45V24	10
10	1,6 mm KP10507-16 Gas-lens	45V25	10
10	2,0-2,4 mm KP10507-24 Gas-lens	45V26	10
10	3,2 mm KP10507-32 Gas-lens	45V27	10
10	4,0 mm KP10507-40 Gas-lens	45V28	10
11	6,5 mm KP10515-4 Ceramic Nozzle	54N18	10
11	8,0 mm KP10515-5 Ceramic Nozzle	54N17	10
11	9,5 mm KP10515-6 Ceramic Nozzle	54N16	10
11	11,0 mm KP10515-7 Ceramic Nozzle	54N15	10
11	12,5 mm KP10515-8 Ceramic Nozzle	54N14	10
11	17,5 mm KP10515-12 Ceramic Nozzle	54N19	10



# Torches Air-cooled

## LT 17 GV Air-cooled

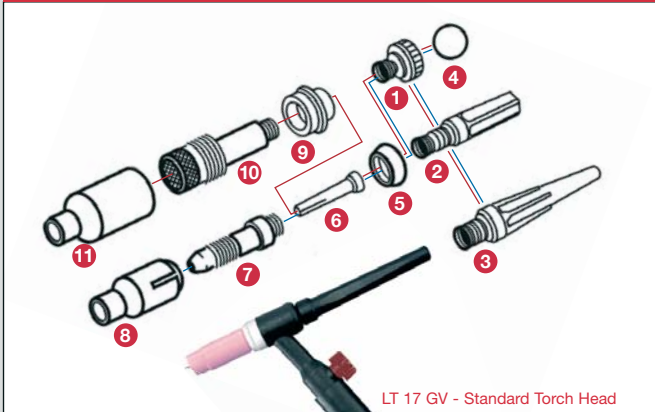

LT 17 GV - Standard Torch Head

Product	Item nr.	Amp.
LT 17 GV 4 mtr 10-25 conn.	K10513-17-4VS	140 A DC 100 A AC @ 35%
LT 17 GV 8 mtr 10-25 conn.	K10513-17-8VS	
LT 17 GV 4 mtr 35-50 conn.	K10513-17-4V	
LT 17 GV 8 mtr 35-50 conn.	K10513-17-8V	
Accessory kit 1,6 - 2,4 mm	KP10516-11	

## LT 26 G Air-cooled



LT 26 G - Standard Torch Head

Product	Item nr.	Amp.
LT 26 G 4 mtr Ergo	K10513-26-4	180 A DC 130 A AC @ 35%
LT 26 G 8 mtr Ergo	K10513-26-8	
LT 26 G 4 mtr Lever	K10513-26-4F	
LT 26 G 8 mtr Lever	K10513-26-8F	
Accessory kit 2,4 - 3,2 mm	KP10516-12	

		Item	Description	Int.	Pcs./pck		
Gas-lens	STANDARD	1	Short cap	57Y04	10		
		2	Medium cap	57Y05	10		
		3	Long cap	57Y02	10		
		4	O-ring	300M02	10		
STANDARD	5	Standard Insulator	18CG	10			
	6	1,0 mm	KP10503-10	Collet	10N22	10	
		1,6 mm	KP10503-16	Collet	10N23	10	
		2,4 mm	KP10503-24	Collet	10N24	10	
		3,2 mm	KP10503-32	Collet	10N25	10	
		4,0 mm	KP10503-40	Collet	54N20	10	
	7	0,5-1,0 mm	KP10505-10	Collet Body	10N30	10	
		1,6 mm	KP10505-16	Collet Body	10N31	10	
		2,4 mm	KP10505-24	Collet Body	10N32	10	
		3,2 mm	KP10505-32	Collet Body	10N28	10	
STANDARD	8	6,5 mm	KP10514-4	Ceramic Nozzle	10N50	10	
		8,0 mm	KP10514-5	Ceramic Nozzle	10N49	10	
		9,5 mm	KP10514-6	Ceramic Nozzle	10N48	10	
		11,0 mm	KP10514-7	Ceramic Nozzle	10N47	10	
		12,5 mm	KP10514-8	Ceramic Nozzle	10N46	10	
		16,0 mm	KP10514-10	Ceramic Nozzle	13N45	10	
Gas-lens	STANDARD	9	Standard Insulator	18CG	10		
		10	0,5-1,0 mm	KP10507-10	Gas-lens	45V24	10
			1,6 mm	KP10507-16	Gas-lens	45V25	10
			2,0-2,4 mm	KP10507-24	Gas-lens	45V26	10
			3,2 mm	KP10507-32	Gas-lens	45V27	10
		4,0 mm	KP10507-40	Gas-lens	45V28	10	
		11	6,5 mm	KP10515-4	Ceramic Nozzle	54N18	10
8,0 mm	KP10515-5		Ceramic Nozzle	54N17	10		
9,5 mm	KP10515-6		Ceramic Nozzle	54N16	10		
11,0 mm	KP10515-7		Ceramic Nozzle	54N15	10		
12,5 mm	KP10515-8		Ceramic Nozzle	54N14	10		
		17,5 mm	KP10515-12	Ceramic Nozzle	54N19	10	

		Item	Description	Int.	Pcs./pck		
Gas-lens	STANDARD	1	Short cap	57Y04	10		
		2	Medium cap	57Y05	10		
		3	Long cap	57Y02	10		
		4	O-ring	300M02	10		
STANDARD	5	Standard Insulator	18CG	10			
	6	1,0 mm	KP10503-10	Collet	10N22	10	
		1,6 mm	KP10503-16	Collet	10N23	10	
		2,4 mm	KP10503-24	Collet	10N24	10	
		3,2 mm	KP10503-32	Collet	10N25	10	
		4,0 mm	KP10503-40	Collet	54N20	10	
	7	0,5-1,0 mm	KP10505-10	Collet Body	10N30	10	
		1,6 mm	KP10505-16	Collet Body	10N31	10	
		2,4 mm	KP10505-24	Collet Body	10N32	10	
		3,2 mm	KP10505-32	Collet Body	10N28	10	
STANDARD	8	6,5 mm	KP10514-4	Ceramic Nozzle	10N50	10	
		8,0 mm	KP10514-5	Ceramic Nozzle	10N49	10	
		9,5 mm	KP10514-6	Ceramic Nozzle	10N48	10	
		11,0 mm	KP10514-7	Ceramic Nozzle	10N47	10	
		12,5 mm	KP10514-8	Ceramic Nozzle	10N46	10	
		16,0 mm	KP10514-10	Ceramic Nozzle	10N45	10	
Gas-lens	STANDARD	9	Standard Insulator	18CG	10		
		10	0,5-1,0 mm	KP10507-10	Gas-lens	45V24	10
			1,6 mm	KP10507-16	Gas-lens	45V25	10
			2,0-2,4 mm	KP10507-24	Gas-lens	45V26	10
			3,2 mm	KP10507-32	Gas-lens	45V27	10
		4,0 mm	KP10507-40	Gas-lens	45V28	10	
		11	6,5 mm	KP10515-4	Ceramic Nozzle	54N18	10
8,0 mm	KP10515-5		Ceramic Nozzle	54N17	10		
9,5 mm	KP10515-6		Ceramic Nozzle	54N16	10		
11,0 mm	KP10515-7		Ceramic Nozzle	54N15	10		
12,5 mm	KP10515-8		Ceramic Nozzle	54N14	10		
		17,5 mm	KP10515-12	Ceramic Nozzle	54N19	10	

# Torches Water-cooled

## LT 20 W Water-cooled

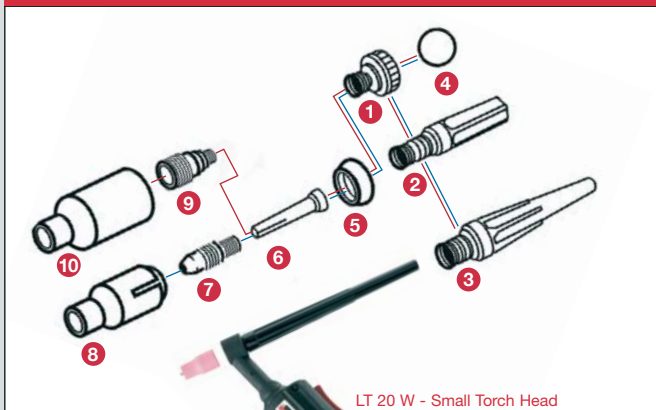

LT 20 W - Small Torch Head





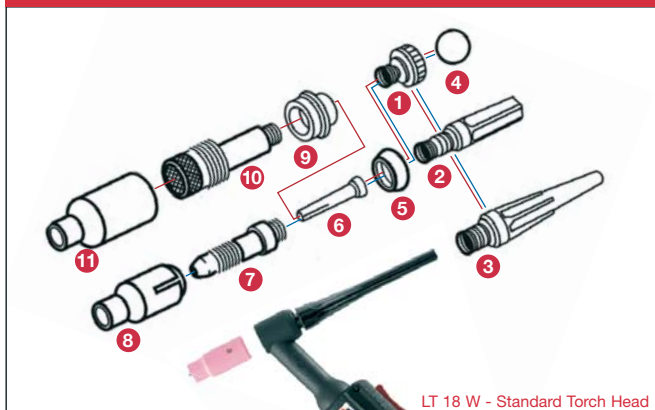























Product	Item nr.	Amp.
LT 20 W 4 mtr Ergo	K10513-20-4	220 A DC 160 A AC @ 100%
LT 20 W 8 mtr Ergo	K10513-20-8	
LT 20 W 4 mtr Lever	K10513-20-4F	
LT 20 W 8 mtr Lever	K10513-20-8F	
Accessory kit 1,6 - 2,4 mm	KP10516-10	

































## LT 18 W Water-cooled



LT 18 W - Standard Torch Head

Product	Item nr.	Amp.
LT 18 W 4 mtr Ergo	K10513-18-4	320 A DC 230 A AC @ 100%
LT 18 W 8 mtr Ergo	K10513-18-8	
LT 18 W 4 mtr Lever	K10513-18-4F	
LT 18 W 8 mtr Lever	K10513-18-8F	
Accessory kit 1,6 - 2,4 mm	KP10516-11	

		Item	Description	Int.	Pcs./pck	
Gas-lens	STANDARD	 KP10508-1	Short cap	41V33	10	
		 KP10508-2	Medium cap	41V35	10	
		 KP10508-3	Long cap	41V24	10	
		 KP10508-4	O-ring	VS-1-02	10	
Gas-lens	STANDARD	 KP10510-1	Standard Insulator	598882	10	
		 1,0 mm	Collet	13N21	10	
		 1,6 mm	Collet	13N22	10	
		 2,4 mm	Collet	13N23	10	
	 3,2 mm	Collet	13N24	10		
	Gas-lens	STANDARD	 0,5-1,0 mm	Collet Body	13N26	10
			 1,6 mm	Collet Body	13N27	10
			 2,4 mm	Collet Body	13N28	10
 3,2 mm			Collet Body	13N29	10	
Gas-lens	STANDARD	 6,5 mm	Ceramic Nozzle	13N08	10	
		 8,0 mm	Ceramic Nozzle	13N09	10	
		 9,5 mm	Ceramic Nozzle	13N10	10	
		 11,0 mm	Ceramic Nozzle	13N11	10	
		 12,5 mm	Ceramic Nozzle	13N12	10	
		 16,0 mm	Ceramic Nozzle	13N13	10	
Gas-lens	STANDARD	 0,5-1,0 mm	Gas-lens	45V42	10	
		 1,6 mm	Gas-lens	45V43	10	
		 2,4 mm	Gas-lens	45V44	10	
		 3,2 mm	Gas-lens	45V45	10	
Gas-lens	STANDARD	 6,5 mm	Ceramic Nozzle	53N58	10	
		 8,0 mm	Ceramic Nozzle	53N59	10	
		 9,5 mm	Ceramic Nozzle	53N60	10	
		 11,0 mm	Ceramic Nozzle	53N61	10	
		 12,5 mm	Ceramic Nozzle	53N61S	10	

		Item	Description	Int.	Pcs./pck	
Gas-lens	STANDARD	 KP10509-1	Short cap	57Y04	10	
		 KP10509-2	Medium cap	57Y05	10	
		 KP10509-3	Long cap	57Y02	10	
		 KP10509-4	O-ring	300M02	10	
Gas-lens	STANDARD	 KP10511-1	Standard Insulator	18CG	10	
		 1,0 mm	Collet	10N22	10	
		 1,6 mm	Collet	10N23	10	
		 2,4 mm	Collet	10N24	10	
	 3,2 mm	Collet	10N25	10		
	 4,0 mm	Collet	54N20	10		
	Gas-lens	STANDARD	 0,5-1,0 mm	Collet Body	10N30	10
			 1,6 mm	Collet Body	10N31	10
 2,4 mm			Collet Body	10N32	10	
 3,2 mm			Collet Body	10N28	10	
Gas-lens	STANDARD	 6,5 mm	Ceramic Nozzle	10N50	10	
		 8,0 mm	Ceramic Nozzle	10N49	10	
		 9,5 mm	Ceramic Nozzle	10N48	10	
		 11,0 mm	Ceramic Nozzle	10N47	10	
		 12,5 mm	Ceramic Nozzle	10N46	10	
		 16,0 mm	Ceramic Nozzle	10N45	10	
Gas-lens	STANDARD	 19,0 mm	Ceramic Nozzle	10N44	10	
		 KP10511-1	Standard Insulator	18CG	10	
		 0,5-1,0 mm	Gas-lens	45V24	10	
		 1,6 mm	Gas-lens	45V25	10	
		 2,0-2,4 mm	Gas-lens	45V26	10	
		 3,2 mm	Gas-lens	45V27	10	
		 4,0 mm	Gas-lens	45V28	10	
Gas-lens	STANDARD	 6,5 mm	Ceramic Nozzle	54N18	10	
		 8,0 mm	Ceramic Nozzle	54N17	10	
		 9,5 mm	Ceramic Nozzle	54N16	10	
		 11,0 mm	Ceramic Nozzle	54N15	10	
		 12,5 mm	Ceramic Nozzle	54N14	10	
		 17,5 mm	Ceramic Nozzle	54N19	10	

# Specialties

## Torches with Flexible head



Type LT 9	Item nr.	Type LT 17	Item nr.	Type LT 26	Item nr.
LT 9 G Flex 4 mtr Ergo	KP10513-9-4X	LT 17 G Flex 4 mtr Ergo	KP10513-17-4X	LT 26 G Flex 4 mtr Ergo	KP10513-26-4X
LT 9 G Flex 8 mtr Ergo	KP10513-9-8X	LT 17 G Flex 8 mtr Ergo	KP10513-17-8X	LT 26 G Flex 8 mtr Ergo	KP10513-26-8X
LT 9 G Flex 4 mtr Lever	KP10513-9-4FX	LT 17 G Flex 4 mtr Lever	KP10513-17-4FX	LT 26 G Flex 4 mtr Lever	KP10513-26-4FX
LT 9 G Flex 8 mtr Lever	KP10513-9-8FX	LT 17 G Flex 8 mtr Lever	KP10513-17-8FX	LT 26 G Flex 8 mtr Lever	KP10513-26-8FX

## Special ceramic nozzles



Type LT 9/20	Item	Int.	Size ø mm	Length mm	Pcs./pck	Type LT 17/18/26	Item	Int.	Size ø mm	Length mm	Pcs./pck
	KP10512-3-L1	796F70	4 mm	48 mm	10		KP10515-4	54N18	6,5 mm	42 mm	10
	KP10512-4-L1	796F71	6,5 mm	48 mm	10		KP10515-5	54N17	8 mm	42 mm	10
	KP10512-5-L1	796F72	8 mm	48 mm	10		KP10515-6	54N16	9,5 mm	42 mm	10
	KP10512-6-L1	796F73	9,5 mm	48 mm	10		KP10515-7	54N15	11 mm	42 mm	10
	KP10512-3-L2	796F74	4 mm	63 mm	10		KP10515-8	54N14	12,5 mm	42 mm	10
	KP10512-4-L2	796F75	6,5 mm	63 mm	10		KP10515-12	54N19	17,5 mm	42 mm	10
	KP10512-5-L2	796F76	8 mm	63 mm	10		KP10514-4-L2	54N18L	6,5 mm	76 mm	10
	KP10512-6-L2	796F77	9,5 mm	63 mm	10		KP10514-5-L2	54N17L	8 mm	76 mm	10
	KP10512-4-L3	796F79	6,5 mm	89 mm	10		KP10514-6-L2	54N16L	12,5 mm	76 mm	10
	-	-	-	-	-		KP10514-7-L2	54N15L	11 mm	76 mm	10

## Tungsten Electrode Selection

Type of electrode	Radiation free	Diameter mm	Length mm	Current	Item nr.	Pcs/pck	Typical fields applications	Welding properties	Recommendation
WC 20 2% Ceriated  Head Colour <b>WHITE</b>	YES	1,0 mm	175 mm	AC/DC	2104797	10	<ul style="list-style-type: none"> <li>• Non and high alloyed steels</li> <li>• Aluminium alloys</li> <li>• Magnesium alloys</li> <li>• Titanium alloys</li> <li>• Nickel alloys</li> <li>• Copper alloys</li> </ul>	<ul style="list-style-type: none"> <li>• Excellent ignition and reignition performance</li> <li>• Long service life</li> <li>• High loadability</li> </ul>	<ul style="list-style-type: none"> <li>• Universal Electrode (WC20 outperforms WT20)</li> </ul>
	YES	1,6 mm	175 mm	AC/DC	2103864	10			
	YES	2,0 mm	175 mm	AC/DC	2103868	10			
	YES	2,4 mm	175 mm	AC/DC	2103865	10			
	YES	3,2 mm	175 mm	AC/DC	2103866	10			
	YES	4,0 mm	175 mm	AC/DC	2103867	5			
GOLD 1,5% Lanthanated  Head Colour <b>GOLD</b>	YES	1,6 mm	175 mm	AC/DC	2105396	10	<ul style="list-style-type: none"> <li>• See WC20</li> </ul>	<ul style="list-style-type: none"> <li>• Like WC20, excellent for general TIG applications</li> <li>• Outstanding in the low current range</li> </ul>	<ul style="list-style-type: none"> <li>• Universal electrode specially good for:                             <ul style="list-style-type: none"> <li>- microplasma welding</li> <li>- plasma welding</li> </ul> </li> </ul>
	YES	2,0 mm	175 mm	AC/DC	2105417	10			
	YES	2,4 mm	175 mm	AC/DC	2105414	10			
	YES	3,2 mm	175 mm	AC/DC	2105419	10			
	YES	4,0 mm	175 mm	AC/DC	2105480	5			
	YES	4,8 mm	175 mm	AC/DC	2105481	5			
W Pure Tungsten  Head Colour <b>RED</b>	YES	1,0 mm	175 mm	AC	2104058	10	<ul style="list-style-type: none"> <li>• Aluminium alloys</li> <li>• Magnesium alloys</li> </ul>	<ul style="list-style-type: none"> <li>• Stable arc with AC</li> <li>• Not suitable for DC</li> </ul>	<ul style="list-style-type: none"> <li>• Aluminium welding</li> </ul>
	YES	1,6 mm	175 mm	AC	2104069	10			
	YES	2,0 mm	175 mm	AC	2104074	10			
	YES	2,4 mm	175 mm	AC	2104080	10			
	YES	3,2 mm	175 mm	AC	2104091	5			
	YES	4,0 mm	175 mm	AC	2104102	5			
	YES	4,8 mm	175 mm	AC	2104113	5			

Your Lincoln Electric Dealer:

**LINCOLN**<sup>®</sup>  
**ELECTRIC**

[www.lincolnelectric.eu](http://www.lincolnelectric.eu)