

INVERTEC V320-T AC/DC CODE 52093

ASSEMBLY PAGE NAME		General Assembly	Base Assembly	Miscellaneous items				
CODE NO.:	FIGURE NO.:	A	B					
52093	V320-T AC/DC CE	1	1	1				

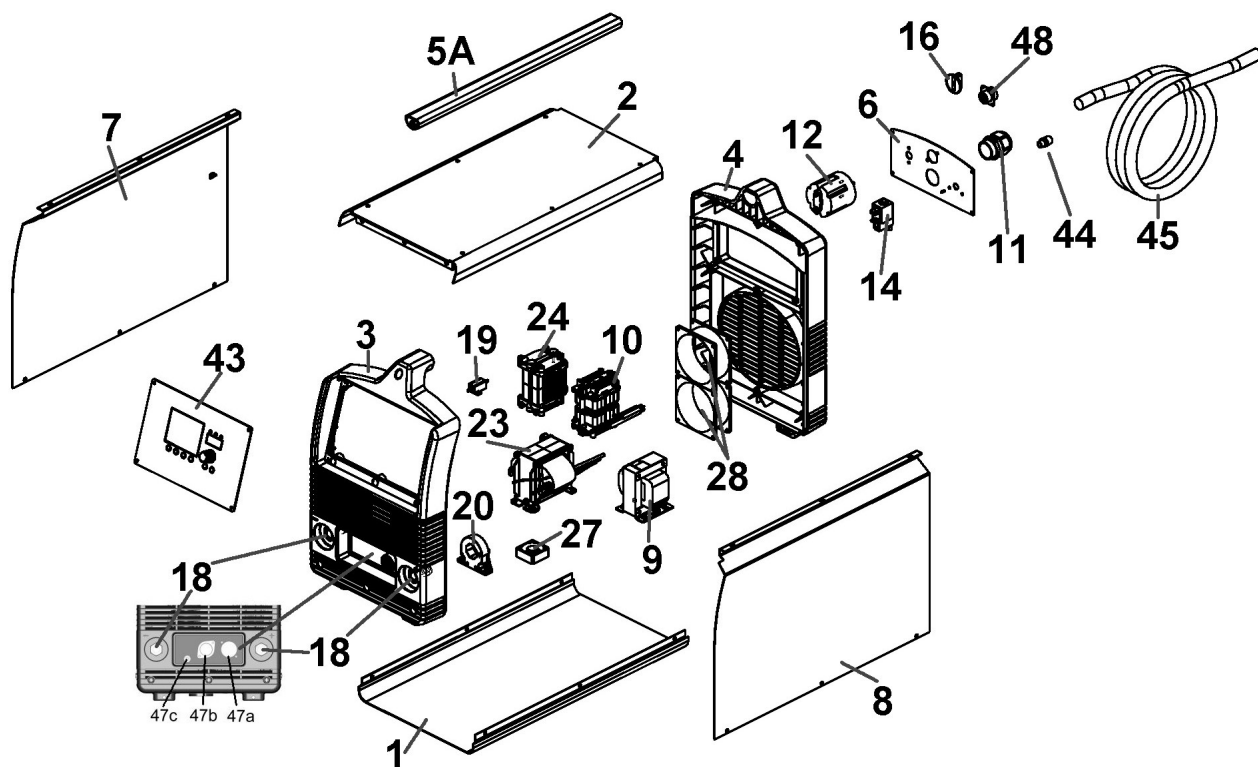

Figure A

Figure A: General Assembly

Item	Description	Part Number	QTY	1	2	3	4	5	6
1	Base	S25310-3	1	X					
2	Top Cover	S26935-2	1	X					
3	Case Front	S26935-3	1	X					
4	Case Back	S26935-4	1	X					
5A	Handle	S26935-5	1	X					
	Screw (Not Shown)	S26935-54	2	X					
6	Rear Nameplate	S26935-61	1	X					
7	Left Cover & Decal V320	S26935-63	1	X					
8	Right Cover & Decal V320	S26935-65	1	X					
9	Output Choke	S26935-66	1	X					
10	Input Choke	S26935-67	1	X					
11	Cable Clamp	S26935-11	1	X					
12	Switch	S26935-12	1	X					
14	Solenoid Valve	S26935-14	1	X					
16	Knob	S25310-13	1	X					
18	Twist Mate Connector	S26935-18	2	X					
19	Output Resistor, 470 Ohm, 25 Watt	S26935-19	1	X					
20	Hall Effect Current Sensor	S26935-20	1	X					
23	Transformer	S26935-23	1	X					
24	H.F. Transformer	S26935-24	1	X					

27	Inverter & PFC Cooling Fan	S26935-27	1	X					
28	Fan	S26935-68	2	X					
43	Control Panel (Display & Control)	S26935-70	1	X					
44	Gas Inlet Fitting	S26935-71	1	X					
45	Input Cord	S52071-19	1	X					
47a	Remote Control Connector	S26935-47	1	X					
47b	Remote Trigger Connector	S25310-34	1	X					
47c	Quick Gas Connector	S25310-36	1	X					
48	CAN bus Connector	S26935-72	1	X					

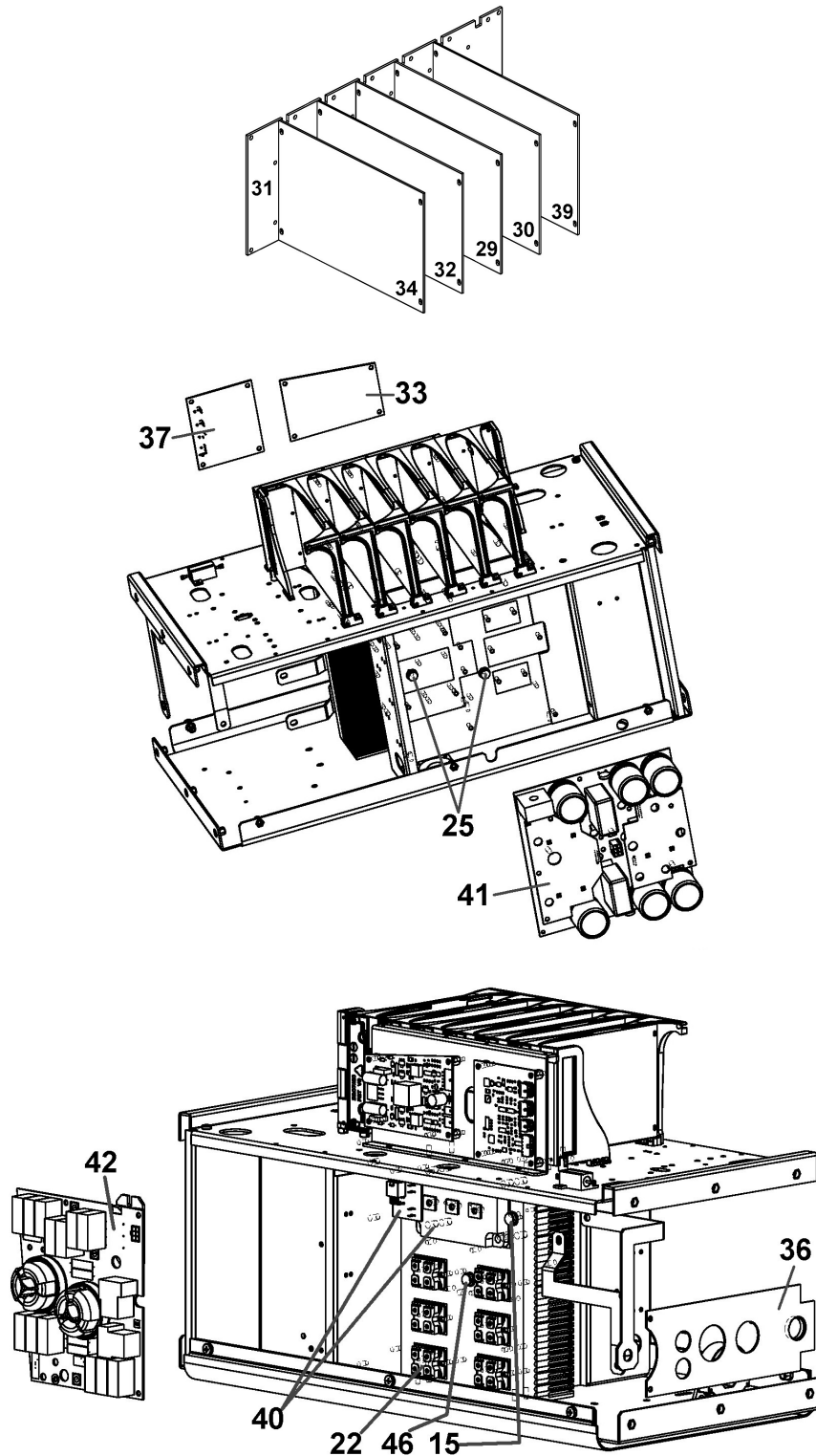

Figure B

Figure B: Base Assembly

Item	Description	Part Number	QTY	1	2	3	4	5	6
15	Thermostat, Output Rectifier	S26935-15	1	X					
22	Output Rectifier Diode	S26935-22	6	X					
25	Thermostat & NTC Probe, Inverter & PFC	S26935-25	1	X					
29	Digital Processor P.C. Board	S26935-29	1	X					
30	Analog Signal P.C. Board	S26935-30	1	X					
31	Bus P.C. Board	S26935-31	1	X					
32	H.F. P.C. Board	S26935-32	1	X					
33	Output Module Driver P.C. Board	S26935-33	1	X					
34	AC Superimposition P.C. Board	S26935-73	1	X					
36	Output Filter P.C. Board	S26935-36	1	X					
37	A/D Remote Control Conversion P.C. Board	S26935-37	1	X					
39	Auxiliary Power Supply P.C. Board	S26935-39	1	X					
40	Output Module	S26935-40	1	X					
41	Inverter & PFC P.C. Board, Module & Diode Kit	S26935-74	1	X					
42	Input P.C. Board	S26935-75	1	X					
46	NTC Probe, Output Rectifier	S26935-46	1	X					

Miscellaneous Items (not showed in figure A or B)

Item	Description	Part Number	QTY	1	2	3	4	5	6
	Cooler Connector Pass Through Gasket	S25310-32	1	X					